

# OPERATOR'S MANUAL

## TW-i SERIES

### *Capacitor Discharge Stud Welder*

**MODELS:**

**TW-i 250**

**TW-i 250CP**

**TW-i 321**

**TW-i 375**



TRU-WELD EQUIPMENT COMPANY

[www.truweldstudwelding.com](http://www.truweldstudwelding.com)

(330) 725-7744

# CONTENTS

---

<u>Description</u>	<u>Pages</u>
Warranty Information	1
Safety	2
Specifications and Features	3
Product Components	4-5
Screen Operation	6-8
Setup and Welding	9-11
CD Stud Gun Exploded View	12

# WARRANTY INFORMATION

---

## TRU-WELD EQUIPMENT LIMITED WARRANTY

All goods produced by Tru-Weld Equipment shall be warranted against defects including workmanship and components. No other warranties whether expressed, verbal, or implied will apply. Warranties only apply to the original equipment purchaser.

Warranty claims will be limited to either repair or replacement of the defective materials by Tru-Weld Equipment. The location of where the warranty evaluation and repairs are made will be determined at the option of Tru-Weld Equipment. All warranty claim items returned to Tru-Weld Equipment will be at the customer's expense. At the option of Tru-Weld Equipment the defect will either be repaired or replaced. Notice must be provided to Tru-Weld Equipment of a warranty defect within 30 days that the defect or failure is incurred. Warranties are not transferable.

This warranty does not apply for equipment which is used improperly in any fashion including but not exclusive to the following:

- Equipment which has been modified
- Equipment which has not been installed properly
- Equipment which has been used for purposes other than which it had been designed
- Equipment which has not been properly maintained
- Equipment which has been used after a defect had been found
- Equipment which has been damaged in any way

Tru-Weld Equipment will never be liable for consequential damages, loss, or expense occurring directly or indirectly from the use of the equipment covered in this warranty.

**All cables, cable sets, and connectors are not covered under warranty**

### **Two (2) year warranty period from date of purchase**

- |                          |                       |                       |
|--------------------------|-----------------------|-----------------------|
| • TWE250 Power Supply    | • SC900 Power Supply  | • SC2400 Power Supply |
| • TWE250CP Power Supply  | • SC950 Power Supply  | • SC2402 Power Supply |
| • TWE321 Power Supply    | • SC1400Power Supply  | • SC2420 Power Supply |
| • TWE375 Power Supply    | • SC1450 Power Supply | • SC3400 Power Supply |
| • TW-i250 Power Supply   | • SC1600 Power Supply | • SC3402 Power Supply |
| • TW-i250CP Power Supply | • SC1650 Power Supply | • SC3422 Power Supply |
| • TW-i321 Power Supply   | • SC1900 Power Supply |                       |
| • TW-i375 Power Supply   | • SC1950 Power Supply |                       |

### **One (1) year warranty period from date of purchase**

- |                       |                      |                         |
|-----------------------|----------------------|-------------------------|
| • TWESPC Power Supply | • TWP-2 Power Supply | • ACE-P100 Power Supply |
|-----------------------|----------------------|-------------------------|

### **Ninety (90) day warranty period from date of purchase**

- |                         |                            |
|-------------------------|----------------------------|
| • TWEGP CD stud gun     | • TWE17000 HD arc stud gun |
| • TWEG MD CD stud gun   | • TWE18500 MD arc stud gun |
| • TWEHDG HD CD stud gun | • TWE19000 LD arc stud gun |

# SAFETY

---

## Read the safety notices before operating welder

### Electrical

- Due to potential dangerous electrical input and output the **equipment must be disconnected from all incoming power when servicing. Do not operate the equipment with the outer cover removed or with the case open.**
- Capacitors store electrical energy, completely discharge before performing any maintenance.
- Do not use fluids to clean electrical components as these may penetrate the electrical system and cause shorts.
- Connection of the unit into service must be in accordance with the setup procedures as detailed in this manual. Operation of this equipment must be in accordance with all local, regional, and national safety codes.



### Fire

- During welding, small particles of hot metal can be expelled. Ensure that no combustible materials are near the welding area.

### Personal Safety

- Arc rays can burn eyes and skin. Wear protective clothing and eye protection when welding.
- Loud noises from welding can damage hearing. Wear earplugs or other protective gear, if applicable.
- Fumes and gases expelled during welding can be health hazards. Make sure welding is done in a well-ventilated area.
- Hot metal splatter can cause fires and burns. Wear protective clothing, work in an area free of combustible materials, and have a fire extinguisher nearby.



### Maintenance

- All cables must be inspected regularly to ensure that no danger exists from damaged insulation or unsafe electrical connections. Take special note of the cables near the stud gun, this is where maximum wear occurs.

### Training

- Use of this equipment must be limited to authorized personnel only. They must be adequately trained, and have read and understood everything in this manual.
- The manual must be available to operators at all times.

### Installation

- Select a site which is capable of supporting the weight of the equipment.
- Select a site which is clear from heavy foot traffic areas to avoid tripping hazards.
- Select a site that prevents cable damage from equipment and vehicles.
- Do not hang connecting cables over sharp edges or place near heat sources.

# SPECIFICATIONS AND FEATURES

## TW-i Capacitor Discharge Stud Welder Series

The TW-i series of capacitor discharge stud welders incorporates the latest solid state technology into a compact, lightweight, and rugged CD stud welder. This full line of equipment is capable of welding pins, cup head pins, and CD studs ranging from 14-gauge up to 3/8" full-flanged stainless steel studs.

## Specifications

SPECS	TW-i 250	TW-i 250CP	TW-i 321	TW-i 375
SIZE	14" L, 10.5" W, 11.5" H 356mm x 267mm x 292mm			
WEIGHT (Power Supply Only)	18 lbs. (8.1Kg)	18 lbs. (8.1Kg)	20.8 lbs. (9.4Kg)	23.4 lbs. (10.6Kg)
WELD RANGE	14Ga - 1/4" Stainless	14Ga - 1/4" Stainless (including cup head pins)	14Ga - 5/16" Stainless	14Ga - 3/8" Stainless
DUTY CYCLE	18 studs per minute (1/4" settings)	18 studs per minute (1/4" settings)	14 studs per minute (5/16" settings)	10 studs per minute (3/8" settings)
PRIMARY POWER	110 VAC @ 50/60Hz 15 Amp circuit 220 VAC @ 50/60Hz 7.5 Amp circuit			
CHARGE VOLTAGE	35-200 VDC			

\* Specifications are subject to change without prior notification

## Features

- Intuitive Touchscreen Interface with preset values for fast, accurate, and repeatable weld settings
- Set-Point Discharge: Unit discharges directly to a new set point without needing to discharge completely
- Universal Input Voltage: Plug and play, no need to re-tap the machine for 110V or 220V input voltages
- Low input voltage capability enables operation with long extension cords
- Contact and Trigger indicators for fast troubleshooting of hand tool and weld cable maintenance issues
- Thermal and Voltage protection indicators to protect the unit from damage due to overheating or poor input power
- Rigid internal construction minimizes the possibility of components coming loose during rough handling or operation
- Hand tool has been ergonomically designed to reduce operator fatigue for increased welding efficiency
- Hand tool has an adjustable internal spring to apply the correct spring pressure for every welding application
- Hand tool can be configured for B collets, CI (Collet Inserts), Euro collets, or standard tapered chucks

# PRODUCT COMPONENTS

---

Front View



Back View

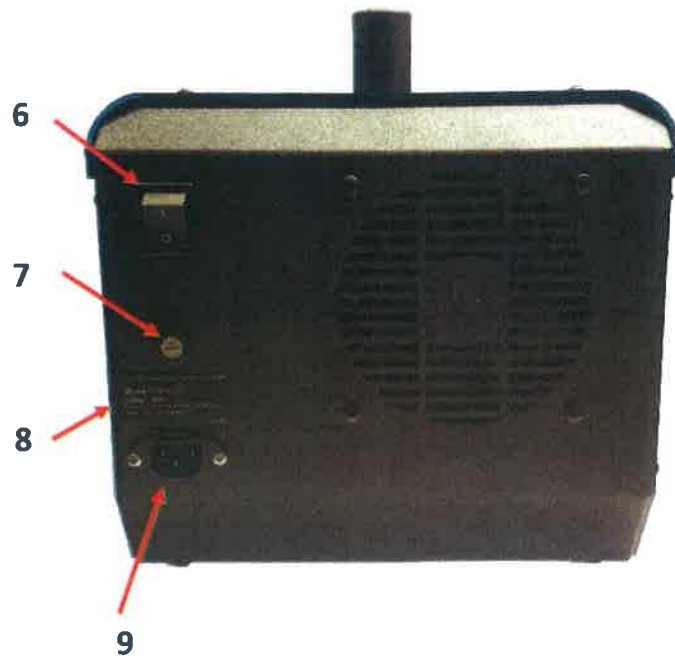

## Components

1. Touch Screen Interface
2. Weld Ground Connector
3. Cup Pin Weld Ground Connector (Model 250CP only, on all other TW-i models this connector is a secondary Weld Ground Connector)
4. Stud Gun Control Cable Connector
5. Stud Gun Weld Cable Connector
6. ON/OFF Switch
7. 10A Fuse
8. Manufacturer Model Number and Serial Number Plate
9. Power Cord Socket



# PRODUCT COMPONENTS

---

## Internal View

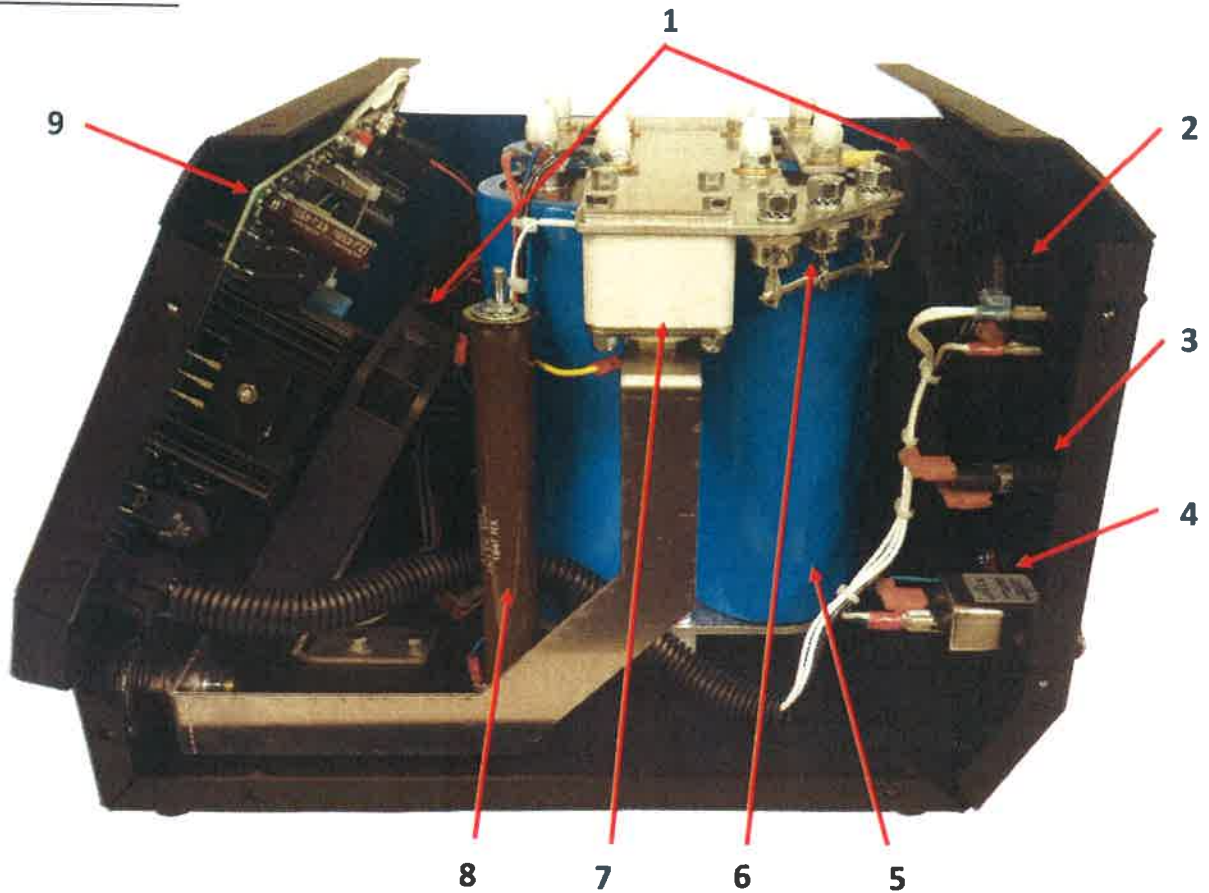

## Components

1. Ventilation Fan
2. ON/OFF Switch
3. 10A Fuse
4. AC Inline Filter/Power Cord Socket
5. Capacitor Bank
6. Freewheeling Diodes
7. SCR/Clamp
8. Discharge Resistor
9. Control Board

# SCREEN OPERATION

## Stud Preset Screen

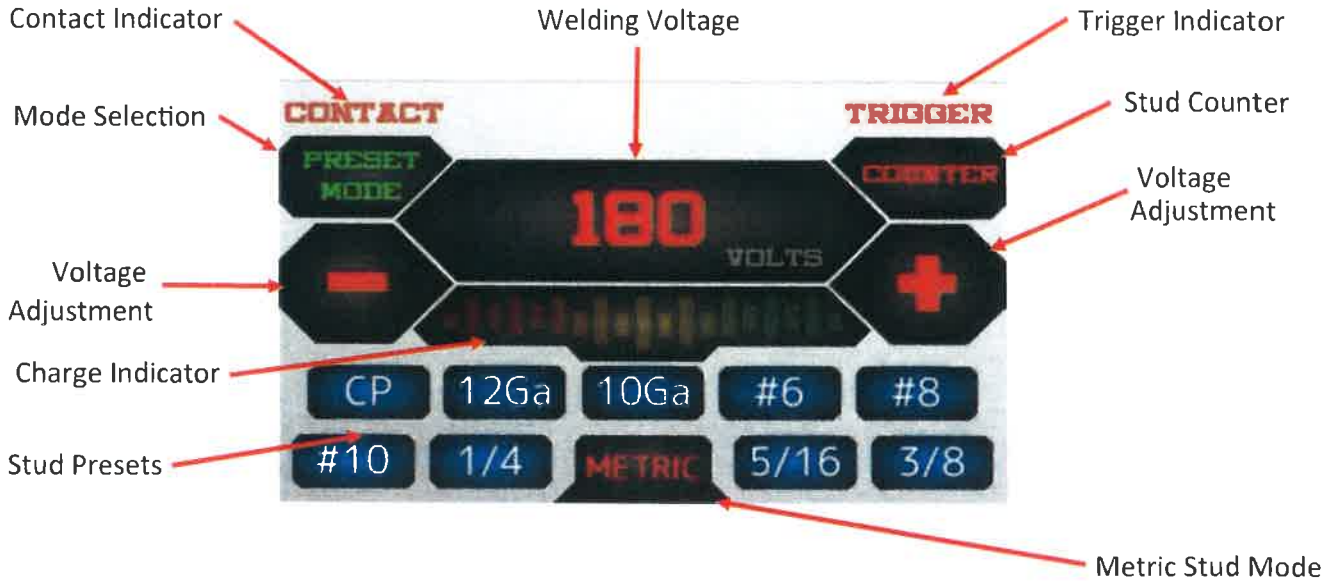

## Voltage Preset Screen





# SCREEN OPERATION

---

## Stud Counter Screen

Stud Count



Stud Counter Reset

## Resetting the Stud Counter



- While on the stud counter screen, press the RESET tab located at the bottom of the screen.
- The screen will then prompt the user for a confirmation to clear the stud counter.
- To cancel the resetting of the stud counter, simply press NO on the screen.
- To confirm the resetting of the stud counter, simply press YES on the screen.

# SCREEN OPERATION

## Screen Status Indicators



Status Indicator	Description	Solution
OVERTEMP	Unit Has Exceeded Temperature Threshold	Unit needs to cool down before more welds can be made. Please allow the unit to cool down and clear the overtemp warning.
UNDER VOLTAGE	Insufficient Input Power	Unit has detected insufficient supply power. Connect the unit to a more stable power supply.
DC LIMIT ON	Duty Cycle Limiter Activated	Protects capacitor from overheating by limiting the user to a maximum average duty cycle. <b><u>This protection only activates when the set point of the welder is above 85V. Below 85V there is no limitation to the duty cycle of the unit.</u></b>
ERR: CHRGE TIME	Max Charge Time Exceeded	Unit has taken too long to charge and there may be an issue with the capacitor. With unit powered down ensure that all connectors and connections are tight.
ERR: OUTPUT	Capacitor Short Detection	Capacitor is not charging properly and the outputs may be shorted. Check the unit for damage as well as the SCR for a short circuit.

# SETUP AND WELDING

## Connecting the Welding Leads

1. Connect the stud gun weld cable into the gun terminal socket on the front of the welding unit. The cable end plug has a flat which aligns with a dot on the panel mount socket. Secure the connector into the panel mount socket, and then turn it clockwise until it locks into proper position. **Failure to properly make these connections could result in damage to the connectors.**
2. Connect the weld gun control cable into the center socket connector. The control cable plug has a large pin and a small pin that match the socket on the unit. Push the plug firmly into the socket and twist clockwise to secure the plug into the correct position.
3. Connect the ground clamp into the ground terminal socket on the front of the unit, this connection is identical to step 1.



## Connecting the Ground Clamp

1. Prior to securing the clamp, make certain that the contact area is free of rust, paint, grease, or any other impurities to ensure a good ground connection.
2. Attach the clamp of the welding ground lead to the work piece.
3. Most applications will require only one ground clamp, **but certain applications will require an additional dual clamp.**



# SETUP AND WELDING

## Selecting the Proper Stud Collet (Stud Holder)

Listed below are the common collet styles, the choice between these setups is usually a matter of personal preference

1. The B collet which is a two-piece assembly (collet and insert). The insert determines how much of the stud is engaged in the collet.
2. The CI (Collet Insert) which is a single part and the amount of the stud that is engaged is predetermined.
3. Standard Adjustable Chucks have an adjustable internal screw to manually adjust for the engagement of the stud.

The collet sizes are based on the diameter of the stud to be welded.

## CD Stud Gun Setup

1. Place the collet into the collet adapter of the stud gun and set the locking screws to hold the collet in place.
2. Mount the two legs and foot piece onto the stud gun. The collet should be centered through the opening of the foot piece.
3. Insert the stud to be welded into the collet.
4. Adjust the leg and foot piece by sliding it into position until approximately 1/8" of the stud protrudes from beyond the foot piece. Lock legs in place with the set screws.
5. The tension setting is adjusted by turning the adjustment cap on the back of the stud gun. On the side of the stud gun is the tension setting indicator, this displays the tension setting of the internal spring.
6. The spring tension setting of the stud gun will vary depending on the application. Generally, mild steel and stainless steel should be set in the 1 to 2 range. Aluminum and other nonferrous metals will require settings in the 3 to 5 range.

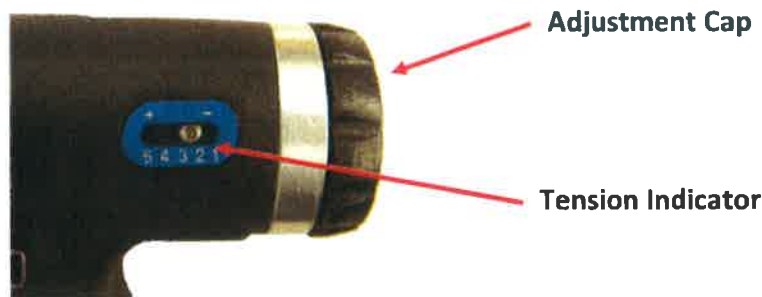
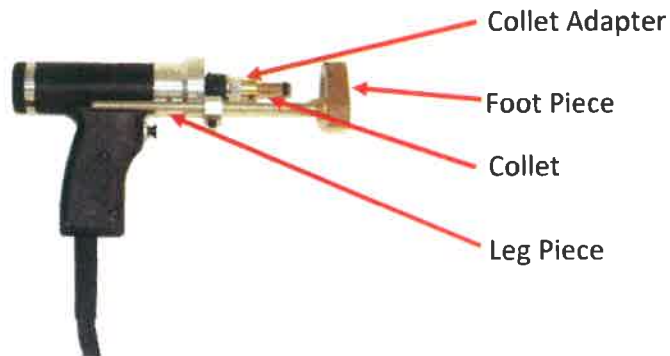

# SETUP AND WELDING

---

## Powering On the Welder

When **all of the previous setup steps** in this manual are complete the welder can be powered on.

1. Ensure that the power cord is connected to the power cord socket and the supply power.
2. Check the 10A fuse below the ON/OFF switch located on the back of the unit.
3. Use the ON/OFF switch to power the unit on.

## Voltage Selection

- The voltage is determined by the diameter of the stud and the base material thickness. The unit is programmed with the recommended voltage settings for various stud sizes. **Fine tuning the voltage for each application from this starting point is recommended.**
- Setting the required weld voltage is achieved by selecting the desired stud size on the screen or manually setting the voltage by using the + or - arrows.
- Fast voltage selection can be done from the voltage mode screen. This will replace the preset values on the screen with voltages in increments of 10V and can be manually adjusted by using the arrows.

## Testing the Weld Settings

1. After performing all of the setup steps listed in this manual, it is recommended that several test welds be performed with the same diameter stud and base material used for the application. This will verify that all of the settings are correct to achieve the desired results.
2. Welding is done by placing the stud into the collet and pressing the stud gun to the work piece.
3. Hold the gun perpendicular to the work piece, align the stud to the desired location, press down so that the foot piece is flush with the base material, and squeeze the trigger.
4. Spreading the collet tines when lifting the stud gun from the welded stud will shorten the life of the collet and will eventually create an undesirable weld. **For maximum collet life remove the stud gun from the welded stud by pulling the stud gun straight off of the welded stud.**
5. Properly welded studs are tested by either torqueing or bending the stud. Using either method the threaded portion of the stud may break. However, the welded flange of the stud should stay in place. Additionally, if the base material is very thin, a full slug the diameter of the flange will pull from the base metal.

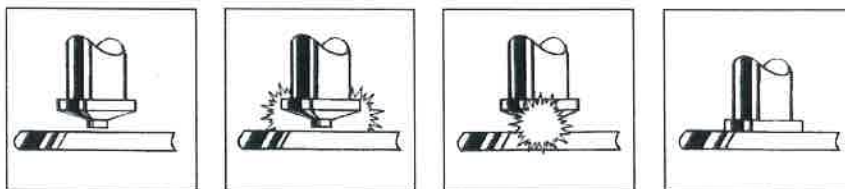

## Inspecting the Weld

1. Visually inspect the weld. If there is a significant amount of splatter then the weld is too hot, lower the voltage. If there is no splatter then the weld is too cold, increase the voltage.
2. A good weld will result in a small, visible, and 360° flashing surrounding the flange of the stud. If there is weld flash on only one side of the base of the flange, this is called “arc blow,” and can be solved by repositioning the ground clamp or using a dual ground clamp.



# CD GUN EXPLODED VIEW

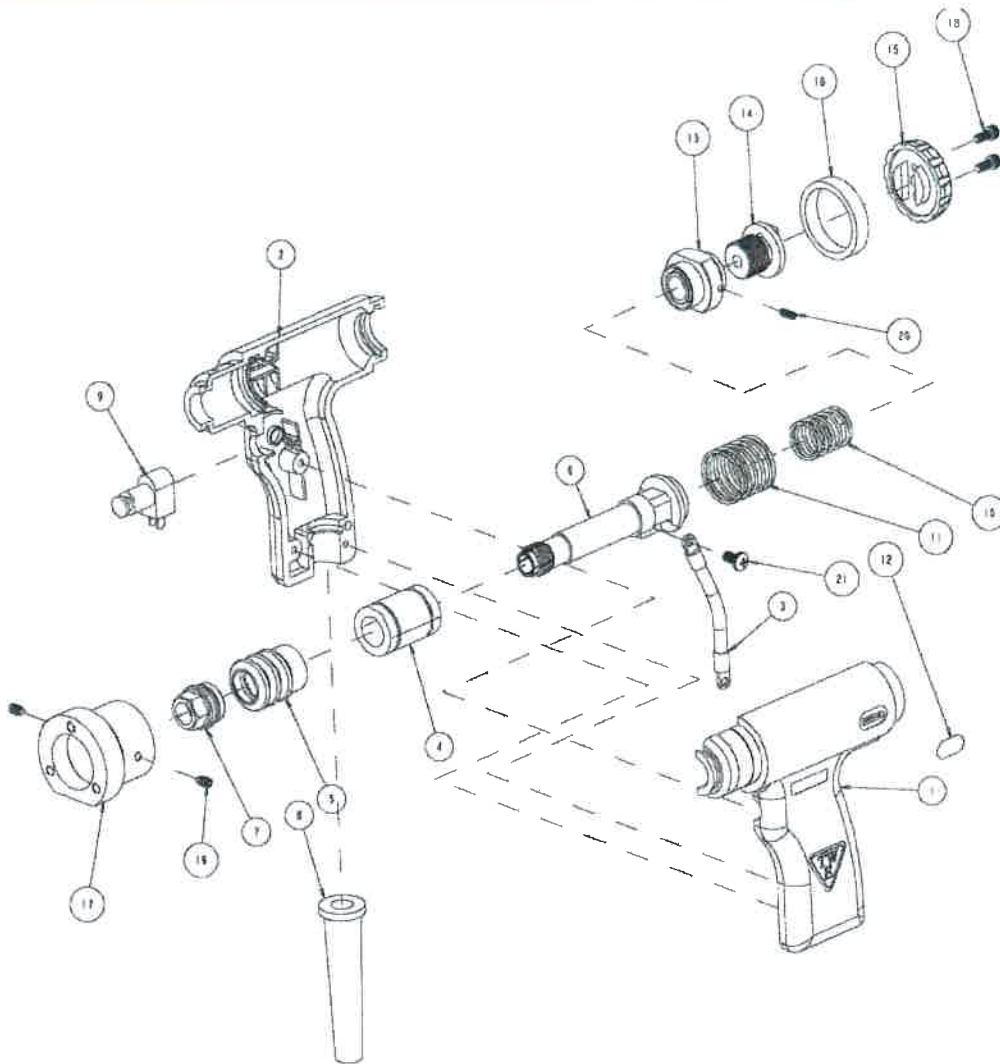

PARTS LIST			
ITEM	QTY	PART No.	DESCRIPTION
1	1	SMG-100L	CD GUN BODY LEFT HALF
2	1	SMG-100R	CD GUN BODY RIGHT HALF
3	1	SMG-101	CD GUN INTERNAL CABLE CONNECTOR
4	1	SMG-102	CD GUN BEARING
5	1	SMG-103	CD GUN BELLOWS
6	1	SMG-104	CD GUN SHAFT
7	1	SMG-105	CD GUN RETAINING NUT
8	1	SMG-106	CD GUN STRAIN RELIEF
9	1	SMG-107	CD GUN TRIGGER SWITCH
10	1	SMG-108	CD GUN SPRING LIGHT COMPRESSION
11	1	SMG-109	CD GUN SPRING HEAVY COMPRESSION
12	1	SMG-110	CD GUN SPRING ADJUSTMENT LABEL
13	1	SMG-111	CD GUN SPRING ADJUSTMENT BLOCK
14	1	SMG-112	CD GUN SPRING ADJUSTMENT SCREW
15	1	SMG-114	CD GUN BACK CAP
16	1	SMG-115	CD GUN LOCKING RING RETAINER
17	1	SMG-117	CD GUN FRONT CAP
18	2	SMG-HDWR-1	#8-32X.375 SOCKET HEAD CAP SCREW
19	2	SMG-HDWR-2	#10-24X.313 HEX SET SCREW
20	1	SMG-HDWR-3	#6-32X.375 HEX SET SCREW
21	1	SMG-HDWR-4	#10-32X.375 CAP HEAD SCREW

19-Sep-12

**TRU-WELD Equipment Company**

**6400 N. Honeytown Road**

**Smithville, Ohio 44677**

**(330) 725-7744 Phone**

**(330) 669-2473 Fax**

**TWE@tfpcorp.com**

**<http://truweldstudwelding.com>**



